

Rückseite des Steckers
mit Terostat-92 abdichten
Plugging the rear side of
the connector with Terostat-92



28980068



1

Schirmring wird nicht benötigt (Lieferumfang 19730621)
Shielding ring is not required (supplied 19730621)

Step 10 Assembly back shell

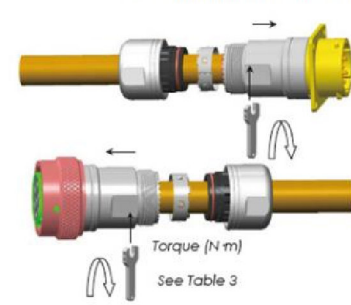

Step 13 Assembly metal nut

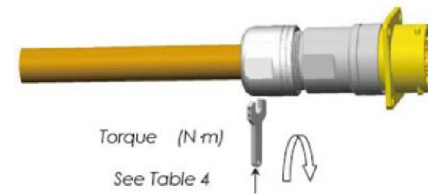
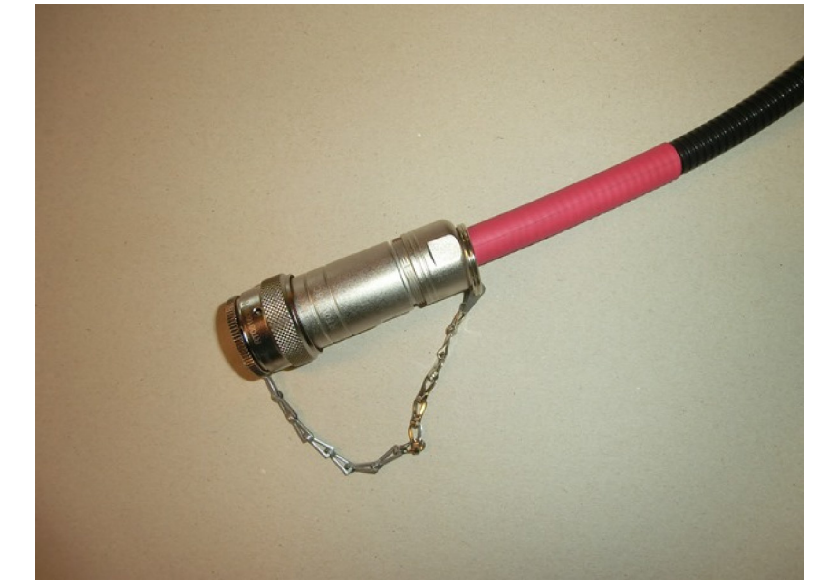

Table 3		Table 4	
Size	Torque=T1 (N.m)	Size	Torque=T2 (N.m)
10	1.5-2.5 N.m	10	2.0-3.0 N.m
12	2.5-4.0 N.m	12	3.0-5.0 N.m
14	2.5-4.0 N.m	14	3.5-5.5 N.m
16	3.0-4.5 N.m	16	4.0-6.0 N.m
18	3.0-4.5 N.m	18	5.0-8.0 N.m



Schrumpfschlauch als Markierung über das Ende
des Wellenschlauches schrumpfen (bündig abschliessend)

Shrink heat tube for marking
over the end of the corrugated tube (to be flush with)

Kette der Schutzkappe mit Schlüsselring verbinden
Connect chain of the protection cap with key ring

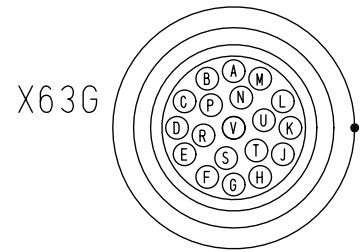

19730621
19730639
19730613

A	—	—	—
B	—	—	—
C	—	—	—
D	—	—	—
E	0.75	A1503	37 WH
F	1.0	A3210	32 WH
G	1.0	A3210	33 WH
H	—	—	—
J	—	—	—
K	—	—	—
L	—	—	—
M	1.0	A3110	4 WH
N	1.0	A3210	32 WH
P	1.0	A3210	33 WH
R	—	—	—
S	0.75	A1503	37 WH
T	0.75	A3110	3 WH
U	0.75	A3110	2 WH
V	—	—	—

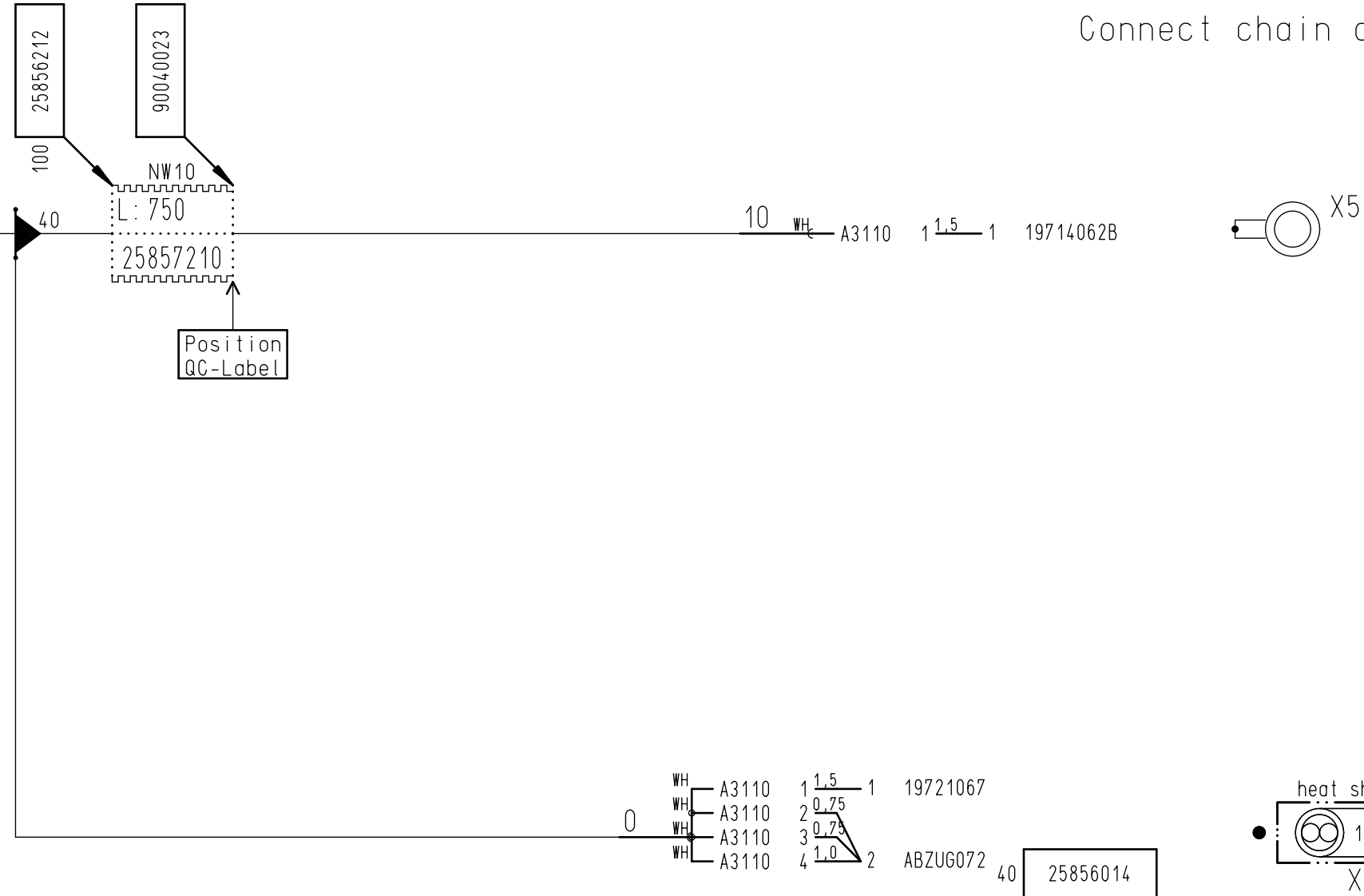

Toleranzen / tolerances	
0 - 100 mm	- 0/+10 mm
101 - 500 mm	-10/+10 mm
501 - 2000 mm	-10/+20 mm
> 2000 mm	-10/+30 mm

The tolerances are made for individual measurements and for the sum of several measurement

All housings with internal length

Type of winding

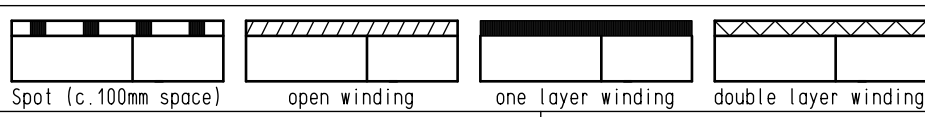

All parts have to be in conformity to IEC 60335-1/-2-72
All housings have to be labeled with device tags

1	1x	3327-00	18.07.16	DK	2015	Date	Name	Citymaster 1600	Name	Kabelbaum W35 (Frontkehrmaschine)	 Hako GmbH D-23840 Bad Oldesloe	Drawing Number		97134142			
A2	No.	Number appears	Change No.	Date	Name	Standard	Verified	Replacem. for same no.	Change No.	3001-73		For this drawing we reserve all rights (acc. DIN ISO 16016)		KABI 472	Type 1491	Dep. ELK	No. of Sh. 2

W35

cutting list-No. : 97134142		cutting list Kabelbaum W35 (Frontkehrmaschine)									
-----------------------------	--	--	--	--	--	--	--	--	--	--	--

wire	Sub	part-No. contact 1	part-No.comp.part	marking 1	wire	cr. sec.	length	colour	marking 2	part-No. contact 2	part-No.comp.part
A1503	37	19721414		X63G/E	26210310	0,75	80	WH	X63G/S	19721414	
A3110	1	19714062B	25856295-L15	X50/1	26210252	1,5	720	WH	XS48/1	19721067	
A3110	2	19721414		X63G/U	26210310	0,75	70	WH	XS48/2	ABZUG072	
A3110	3	19721414		X63G/T	26210310	0,75	70	WH	XS48/2	^	
A3110	4	19721414		X63G/M	26210245	1,0	70	WH	XS48/2	^	
A3210	32	19721414		X63G/F	26210245	1,0	80	WH	X63G/N	19721414	
A3210	33	19721414		X63G/G	26210245	1,0	80	WH	X63G/P	19721414	

1	/.	3327-00	18.07.16	DK	2016	date	name	Citymaster 1600	 Hako GmbH D-23840 Bad Oldesloe	Kabelbaum W35 (Frontkehrmaschine)		
					drawn	27.04.	DK	replaced by : same no.				
					check			rev. No. : 3001-73		type : 1491	97134142	num.ofsh.:2 sheets: 2
No.	changed wire/Sub-No.	Rev.-No.	date	name								

Material: 97134142 wiring harness
 Index: 02
 Change Number: 3327-00

Material	Item	Line	Component	Object description	Material Description	Comp. Qty (CUn)	Un	Internal Comment
97134142	10	1	19714062	Ringkabelschuh ähn. DIN 46225 A6-2,5	ring term. similar DIN 46225 A6-2,5		1 PC	
97134142	10	2						Fa. Lear Nr. 25219.123.322
97134142	20	1	19721067	Stossverbinder >1-2,5 unisoliert	butt connector >1-2,5 not insulated		1 PC	
97134142	20	2						Fa. Lear Nr. 04529.321.011
97134142	30	1	19721414	ST-Kont. RT 1,6mm (0,75-1,5)	tab-cont. RT 1,6mm (0,75-1,5)		9 PC	
97134142	30	2						Fa.Amphenol Nr. SP16M1G10
97134142	40	1	19730613	Stecker für Stiftkontakt 19pol.	socket for pin contact 19-pole		1 PC	
97134142	40	2						Fa. Amphenol Nr. RT061619PNH-Ni
97134142	50	1	19730621	Endgehäuse m.Kabelverschraubung	cord grip, shell size 16		1 PC	
97134142	50	2						Fa.Amphenol Nr. RT0L-16CG-S1-Ni
97134142	60	1	19730639	Staubschutzkappe Stecker	plug dust cap		1 PC	
97134142	60	2						Fa.Amphenol Nr.RT616DCG-15-Ni
97134142	70	1	25856014	Schrumpfsch. 4,5x1-PE 3:1 trans.m.Kleber	heat shrink tube 4,5x1-PE 3:1 tran.glu		0,04 M	
97134142	70	2						Fa. Thulesius Nr. Z85527
97134142	70	3						Meterware
97134142	80	1	25856212	Schrumpfschlauch 12,7x0,6-PVC 2:1 rt	heat shrink tube 12,7x0,6-PVC 2:1 red		0,1 M	
97134142	80	2						Fa. Thulesius Nr. Z85892
97134142	90	1	25856295	Schrumpfschlauch 4,8x0,5-PVC 2:1 bl	heat shrink tube 4,8x0,5-PVC 2:1 blue		0,02 M	
97134142	90	2						Fa. Thulesius Nr. Z85877
97134142	100	1	25857210	Wellschlauch geschlossen NW10 flexibel	corrugated tube NW10		0,75 M	
97134142	100	2						LV: Stöhrmann GmbH (<>&<> Co. KG 50 Meter/Lieferantengebinde (GB 20)
97134142	100	3						-
97134142	100	4						Kanban-Teil Artikelkurzauftrag vorh.
97134142	100	5						
97134142	100	6						
97134142	100	7						Fa.Reiku Nr.PARRB-10F
97134142	110	1	26210245	PVC-Fahrzeugleitung FLRY-B 1x1 weiss	PVC-automotive cable FLRY-B 1x1 white		0,23 M	
97134142	110	2						Fa. NKT Art.: AP040010BNNNNAN
97134142	110	3						
97134142	110	4						DIN 72551 / ISO6722 FLRY-B
97134142	120	1	26210252	PVC-Fahrzeugleitung FLRY-B 1x1,5 weiss	PVC-automotive cable FLRY-B 1x1,5 white		0,72 M	
97134142	120	2						Fa. NKT Art.: AP040015BNNNNAN
97134142	120	3						
97134142	120	4						DIN 72551 / ISO6722 FLRY-B
97134142	130	1	26210310	PVC-Fahrzeugleitung FLRY-B 1x0,75 weiss	PVC-automotive cable FLRY-B 1x0,75 white		0,22 M	
97134142	130	2						Fa. NKT Art.: AP040007BNNNNAN
97134142	130	3						
97134142	130	4						DIN 72551 / ISO6722 FLRY-B
97134142	140	1	28980068	Terostat 92 schwarz	sealing compound		0,1 PCD	
97134142	140	2						Fa. Henkel 310MI
97134142	140	3						Zu verarbeiten mit Reiniger 28420594
97134142	150	1	90040023	Schlüsselring 26,5x22x1,9	key ring		1 PC	